



QPLx2...



QPLx5... / QPHx5...

Pressure Switches

QPL...
QPH...

The pressure switches are used for monitoring gas or air pressures. When the pressure falls below or exceeds the adjusted switching point, the respective electrical circuit will be opened or changes over.

The QPL... / QPH... and this Data Sheet are intended for use by OEMs which integrate the pressure switches in their products.

Use

- For the supervision of air or gas pressures in gas trains of gas-fired equipment (gas burners)
- The QPL... / QPH... are available as pressure switches for minimum or maximum pressure
- Suited for pressure ranges up to 500 mbar
- Suited for gases of gas families 1, 2 and 3 and other neutral gaseous media

Warning notes



To avoid injury to persons, damage to property or the environment, the following warning notes should be observed!

Do not open, interfere with or modify the pressure switch!

- All activities (mounting, installation and service work, etc.) must be performed by qualified staff
- Before making any wiring changes in the connection area of the switch, completely isolate the equipment from the mains supply (all-polar disconnection)
- Ensure protection against electric shock hazard by providing adequate protection for the connection terminals
- Each time work has been carried out (mounting, installation, service work, etc.), check to ensure that wiring is in an orderly state
- Fall or shock can adversely affect the safety functions. Such units must not be put into operation, even if they do not exhibit any damage
- Do not use the pressure switch in inflammable or explosive gas atmospheres

Engineering notes

Setting the switching point

To set the required switching point, remove the cover from the pressure switch and turn the setting knob clockwise to increase the set value, or counterclockwise to decrease it (see scale under «Dimensions»). Replace the cover and secure it to prevent tampering.

Mounting notes

- Ensure that the relevant national safety regulations are complied with
- Check piping connections and housing of the pressure switch to ensure that there are no leaks
- The pressure switch can be mounted either horizontally or vertically, but not in a suspended position (with the scale pointing downward)
- The pressure switch can be connected via a ¼" thread or O-ring, depending on the type of switch (refer to «Connection via ...»)

Connection via ¼" (ISO) thread

QPLx2...

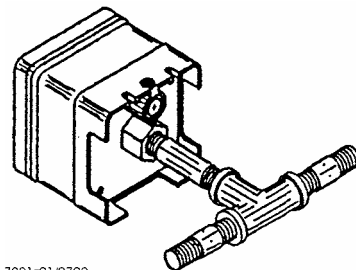

QPLx5... / QPHx5...

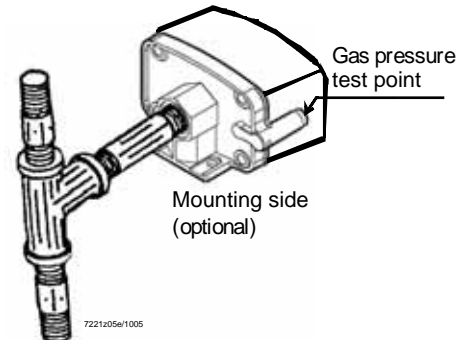

Connection via O-ring

QPLx2...

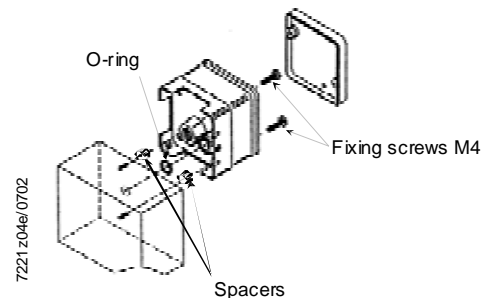

QPLx5... / QPHx5...

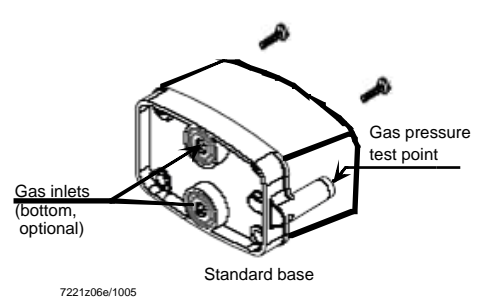

Standards and certificates



Conformity to EEC directives

- Electromagnetic compatibility EMC (immunity) 89 / 336 / EEC
- Directive for gas-fired appliances 90 / 396 / EEC
- Pressure sensing devices for gas burners and gas-fired appliances EN 1854

QPLx2...

(CE 0063 BL 1455)

QPLx5... / QPHx5...

(CE 0085 BR 0021)



ISO 9001: 2000
Cert. 00739



ISO 14001: 2004
Cert. 38233

Disposal notes



The unit contains electrical and electronic components and must not be disposed of together with domestic waste.
Local and currently valid legislation must be observed.

Mechanical design

- Housing made of durable plastic with die-cast aluminium base
- Adjustable switching point
- Automatic reset
- Manual reset at QPLx2... on request

The switching point (setpoint) of the pressure switch is to be set with the adjusting knob located under the securing cover. The pressure switch comes calibrated and has been checked for leaks.

Type summary

When ordering, please give type reference according to «Type summary».

Pressure switches with automatic reset:

Pressure switches
QPL... for minimum
pressure

Pressure range	1/4" connection	O-ring connection	Baufom
1.5...10 mbar	QPL22.010A00 ¹⁾	QPL12.010A00 ¹⁾	QPLx2
2.5...50 mbar	QPL22.050A00	QPL12.050A00	QPLx2
12.5...75 mbar	QPL22.075A00 ¹⁾	QPL12.075A00 ¹⁾	QPLx2
70...280 mbar	QPL22.280A00	QPL12.280A00	QPLx2

Pressure range	1/4" connection	O-ring connection	Baufom
0.7...3 mbar	QPL25.003 ¹⁾	QPL15.003 ¹⁾	QPLx5
2...10 mbar	QPL25.010	QPL15.010	QPLx5
5...50 mbar	QPL25.050	QPL15.050	QPLx5
10...150 mbar	QPL25.150	QPL15.150	QPLx5
100...500 mbar	QPL25.500 ¹⁾	QPL15.500 ¹⁾	QPLx5

Pressure switches
QPH... for maximum
pressure

Pressure range	1/4" connection	O-ring connection	Baufom
5...50 mbar	QPH25.050 ¹⁾	QPH15.050 ¹⁾	QPLx5
10...150 mbar	QPH25.150	QPH15.150	QPLx5

¹⁾ On request

Accessories



Connector for end switch

- Plug-in connector conforming to DIN EN 175301-803-A
- Triple pole + 
- 4.5...11 mm dia. / max. 1.5 mm²

AGA65

Technical data

General data	Switching voltage	DC / AC _{eff} max. 250 V
	Switching current	
	- QPLx2...	AC _{eff} max. 10 A at $\cos\varphi$ 1 AC eff. max. 2 A at $\cos\varphi$ 0.5 AC eff. min. 20 mA DC max. 1 A DC min. 20 mA
	- QPLx5... / QPHx5...	AC _{eff} max. 6 A at $\cos\varphi$ 1 AC eff. max. 2 A at $\cos\varphi$ 0.5 AC eff. min. 20 mA DC max. 1 A DC min. 20 mA
	Adjustable operating pressure range	1.5... 500 mbar (different ranges, refer to «Type summary»)
	Operating pressure (short-time) pressure surge	max. 600 mbar for max. 30 s
	- QPLx2...	max. 1,000 mbar for max. 30 s
	- QPLx5... / QPHx5...	
	Operating pressure (continuously)	
	- QPLx2...	max. 400 mbar
	- QPLx5... / QPHx5...	max. 690 mbar
	Weight	
	- QPLx2...	approx. 225 g
	- QPLx5... / QPHx5...	approx. 120 g
Mounting position	horizontal or vertical, but not suspended	
Safety class		
- QPLx2...	I to VDE 0631	
- QPLx5... / QPHx5...	II to VDE 0631	
Degree of protection		
- QPLx2...	IP 40 (to be ensured through adequate mounting)	
- QPLx5... / QPHx5...	IP 54	
Switching pressure deviation	±15 %, referred to the setpoint (diaphragm in vertical position)	
Gas families	I, II, III	

Typical hysteresis:

Type reference	Switching differential
QPL... / QPH... < 10 mbar	0.5 mbar
QPL... / QPH... < 50 mbar	1 mbar
QPL... / QPH... < 75 mbar	3 mbar
QPL... / QPH... > 100 mbar	5 mbar

Environmental conditions

Storage	DIN EN 60721-3-1
Climatic conditions	class 1K3
Mechanical conditions	class 1M2
Temperature range	-20...+60 °C
Humidity	< 95 % r.h.
Transport	DIN EN 60 721-3-2
Climatic conditions	class 2K2
Mechanical conditions	class 2M2
Temperature range	-40...+60 °C
Humidity	< 95 % r.h.
Operation	DIN EN 60 721-3-3
Climatic conditions	class 3K5
Mechanical conditions	class 3M2
Temperature range	-20...+60 °C
Humidity	< 95 % r.h.



Condensation, formation of ice and ingress of water are not permitted!

Function

Function with automatic reset.

Pressure switches for minimum pressure

Switch opens the electrical circuit when the air or gas pressure falls below the set value.

Pressure switches for maximum pressure

Switch opens the electrical circuit when the air or gas pressure exceeds the set value.

Connection diagram

Pressure switch for minimum pressure

When the pressure falls below the set value, NO opens and NC closes

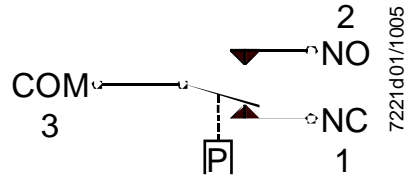

Pressure switch for maximum pressure

When the pressure exceeds the set value, NC opens and NO closes

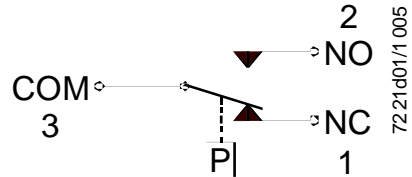

Connection via connector to DIN 43650

QPL2...

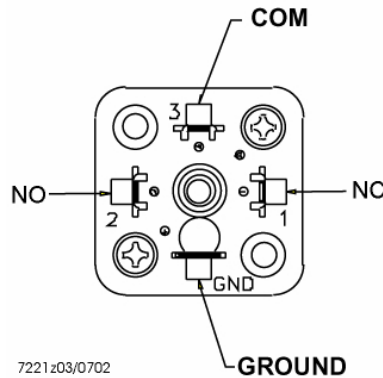

QPLx5... / QPHx5...

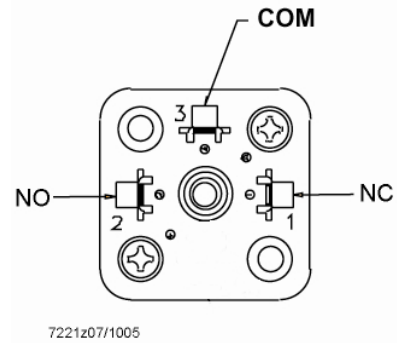

Connection examples

QPLx5... / QPHx5... fitted to VGD20...

QPLx5... / QPHx5... fitted to VGD40...



Dimensions

Dimensions in mm

QPLx2...

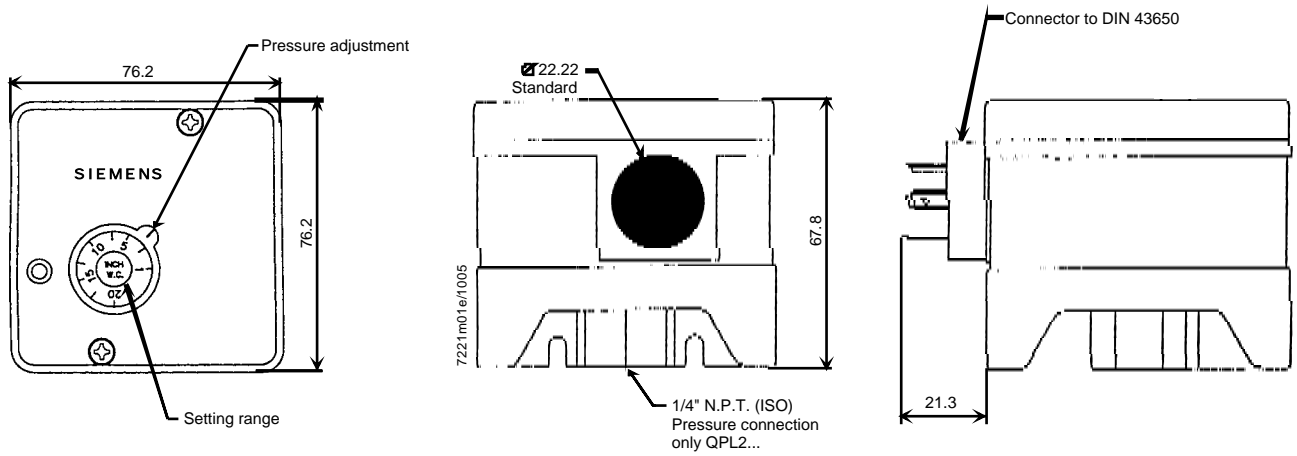

QPLx5... / QPHx5...

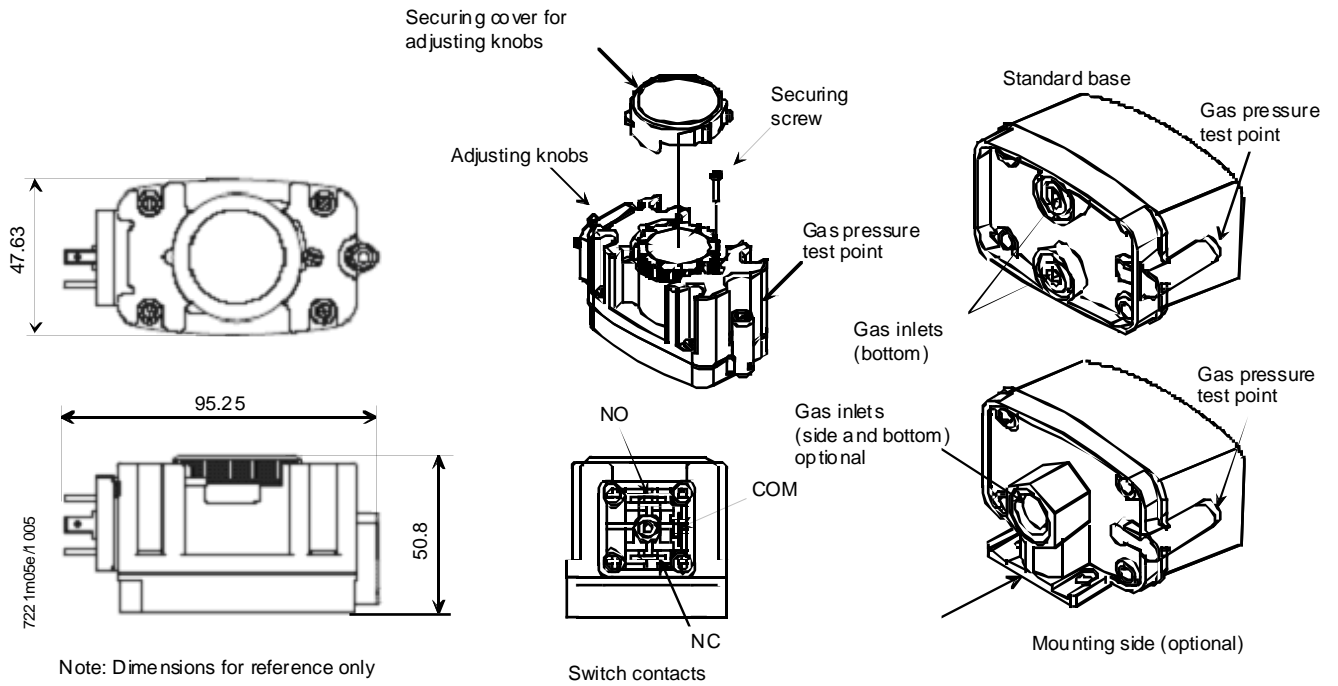

Note: Dimensions for reference only